

**Specification**

| Model       | Needle          | Needle No. | Thread No. | Stitch Width (mm) | Stitch Length (mm) | Differential Ratio | Presser Foot Lifting Height (mm) | Max. Speed (s.p.m) | Volume (mm) | Weight (kg) |
|-------------|-----------------|------------|------------|-------------------|--------------------|--------------------|----------------------------------|--------------------|-------------|-------------|
| K5-UT2-01GB | UY128GAS 11-14# | 3          | 5          | 1.5-4.5           | 5.6/6.4            | 0.8-1.3            | 7                                | 5500               | 670×445×595 | 52/62       |
| K5-UT2-02GB | UY128GAS 11-14# | 3          | 5          | 1.5-4.5           | 5.6/6.4            | 0.8-1.3            | 7                                | 5500               | 670×445×595 | 52/62       |
| K5-UT2-03GB | UY128GAS 11-14# | 3          | 5          | 1.5-4.5           | 5.6/6.4            | 0.8-1.3            | 7                                | 5500               | 670×445×595 | 52/62       |
| K5-UT2-08AC | UY128GAS 11-14# | 3          | 5          | 1.5-4.5           | 5.6/6.4            | 0.8-1.3            | 7                                | 5500               | 670×445×595 | 52/62       |
| K5-UT2-35AC | UY128GAS 11-14# | 3          | 5          | 1.5-4.5           | 5.6/6.4            | 0.8-1.3            | 7                                | 5000               | 670×445×720 | 53/65       |
| K5-D-01GB   | UY128GAS 11-14# | 3          | 5          | 1.5-4.5           | 5.6/6.4            | 0.8-1.3            | 7                                | 5500               | 670×445×595 | 46/56       |
| K5-D-02BB   | UY128GAS 11-14# | 3          | 5          | 1.5-4.5           | 5.6/6.4            | 0.8-1.3            | 7                                | 5500               | 670×445×595 | 46/56       |
| K5-D-03GB   | UY128GAS 11-14# | 3          | 5          | 1.5-4.5           | 5.6/6.4            | 0.8-1.3            | 7                                | 5500               | 670×445×595 | 46/56       |
| K5-D-08AC   | UY128GAS 11-14# | 3          | 5          | 1.5-4.5           | 5.6/6.4            | 0.8-1.3            | 7                                | 5500               | 670×445×595 | 46/56       |
| K5-D-35AC   | UY128GAS 11-14# | 3          | 5          | 1.5-4.5           | 5.6/6.4            | 0.8-1.3            | 7                                | 5000               | 670×445×720 | 47/59       |

Note:

1.UT2: computerized machine, standard: with thread wiper, without upper thread trimmer D: direct drive  
 2.UT type computerized machine is optional, standard: with thread wiper and upper thread trimmer; UTL pneumatic type computerized is optional (pneumatic thread trimming+ pneumatic foot lifter presser)

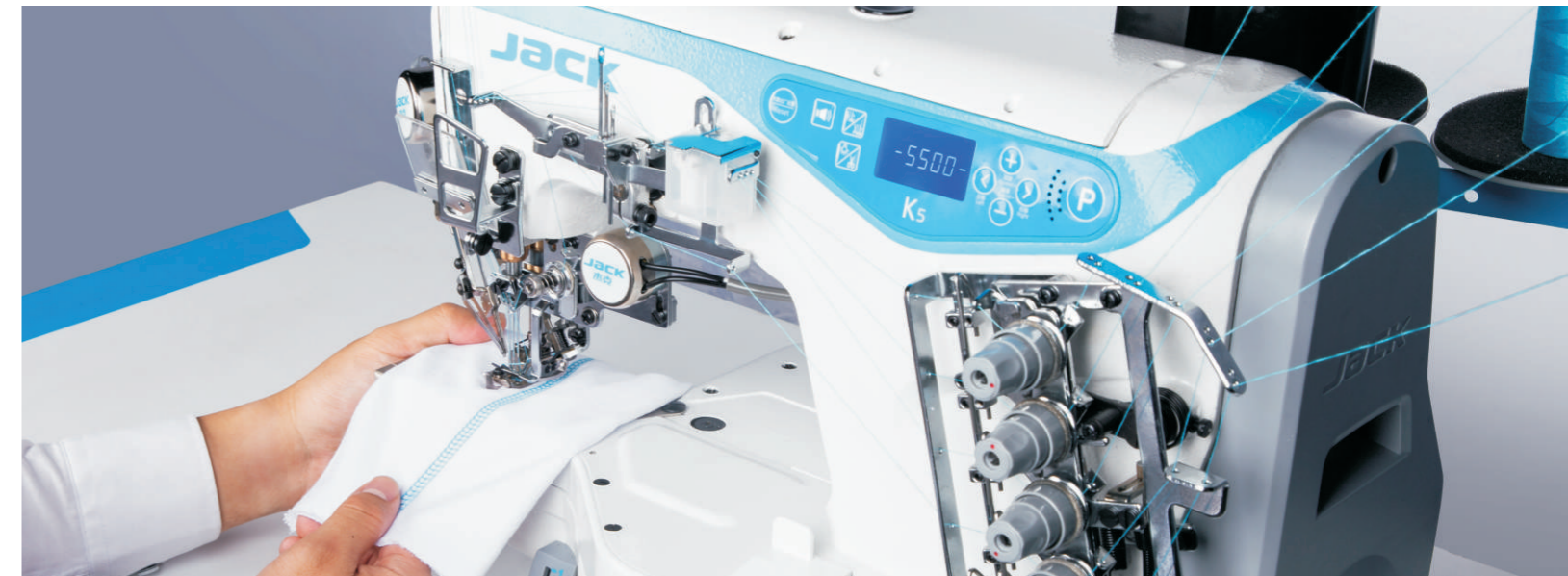

**Super High Speed Computerized Cylinder-bed Interlock Machine**



Jack Wechat



Jack Facebook



K5

2019.09

**JACK SEWING MACHINE CO.,LTD.**

No. 15 South Airport Road, Jiaojiang District, Taizhou, Zhejiang, PRC  
 TEL: 0086-576-8817782 8817767  
 FAX: 0086-576-8817787

E-mail: sales@chinajack.com  
 www.chinajack.com

# K5

Item: Super High Speed Computerized Cylinder-bed Interlock Machine  
 Features: High Speed, Stable, High yield

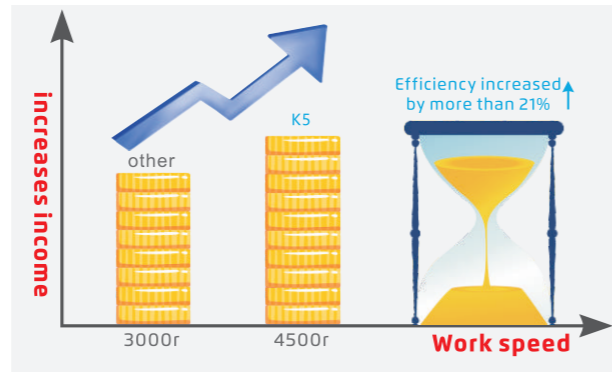

## 1 High speed, high yield

K5's normal working speed is 4500 rpm, compared with 3700rpm of normal interlock machine, the efficiency is increased by more than 21%. if one worker's monthly salary is 4000RMB, it will increase to 4840RMB when using K5 ( $4000 \times (1+0.21) = 4840\text{RMB}$ ), monthly salary increment is 840RMB for workers, which means 1260RMB gain increase per month for the owner, according to the 4:6 income ratio between workers and owner.

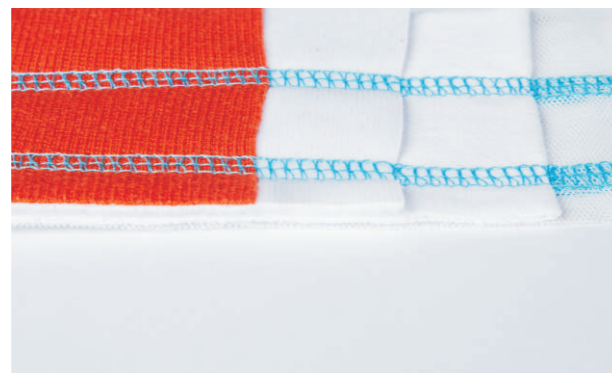
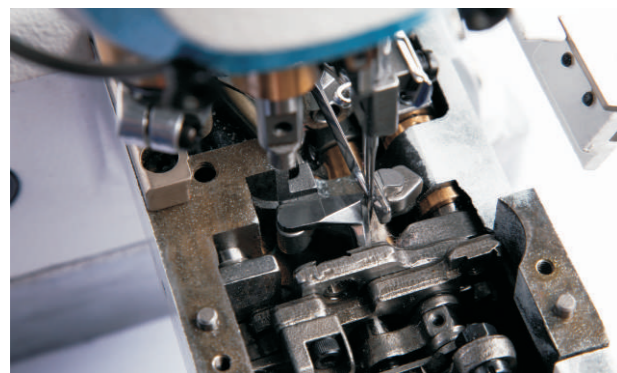

## 2 Stable thread trimming, no skipping

No skipping when start sewing, ensuring high quality sewing fabric, and the thread trimming performance is stable, greatly reducing the occurrence of occasional accident that the thread can't be cut.

## 3 Wide adaptability of fabric

Able to sew the thin material mesh and 8 layers ordinary knitting thickness fabric without any adjustment, and beautiful stitch.



## 4 One key to reset, easy to operate

Users can restore to their own parameters or factory parameters according to the needs, more user-friendly and no need to worry if misuse.

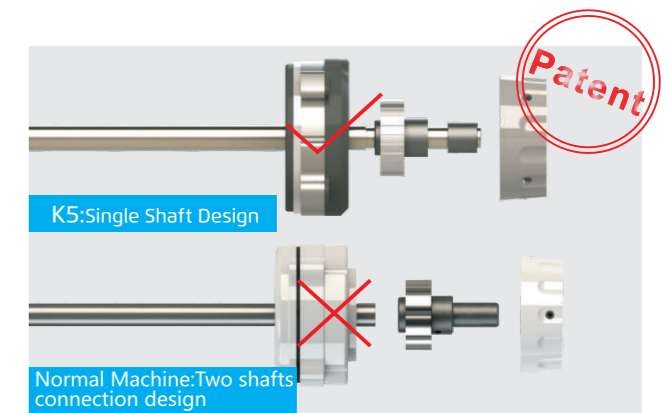

## 5 One main shaft, stable and fast

Reduce the machine torque, making the sewing fast, stable and durable.

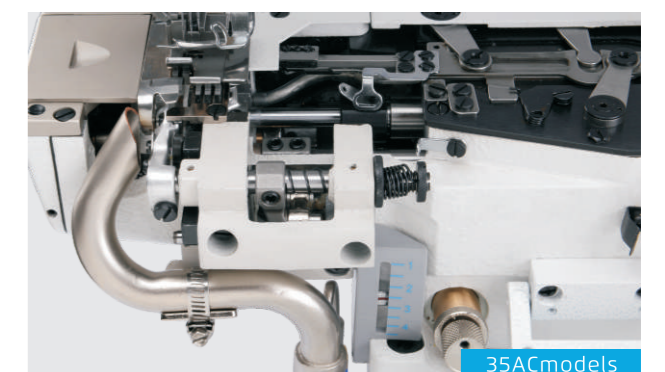
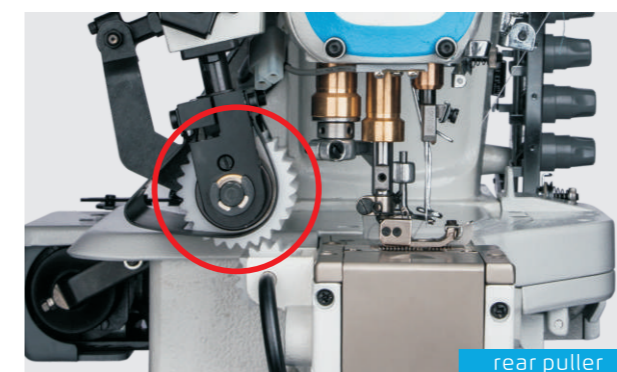

## 6 K5 optional add-on and model